

**STAINLESS
STEEL**

FUME HOOD



CONTENTS

Standard Hood Features	3
Laboratory Fume Handling	4
Stainless Steel Fume Hood -AD Series	5
Models	6
Parts	7
Options and Accessories	8
Warranty	9

Standard Hood Features

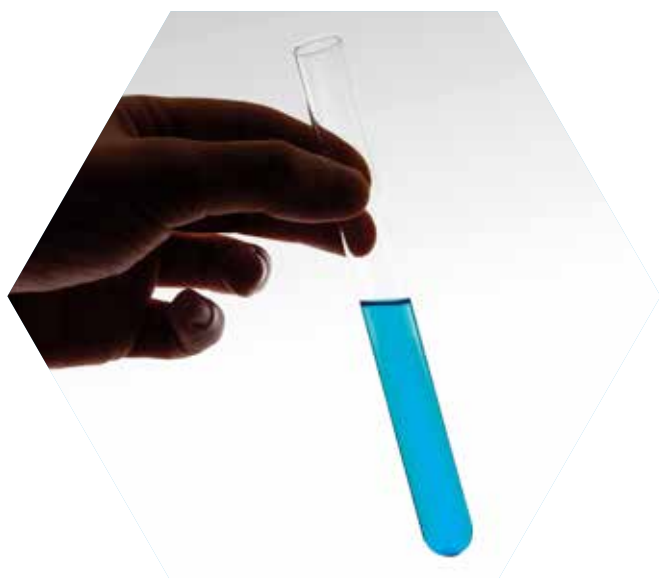

- Double layered design
- Aerodynamic front fascia
- Stainless steel construction
- Heavy epoxy powder coated finish to withstand harsh laboratory environments
- Stainless steel inner liner and baffle with built in slots for efficient scavenging
- Dished stainless steel worktop
- Purpose built light box external to airflow, preventing any corrosion and minimizing turbulence
- Electronic light ballast for flicker free usage and user eye comfort
- Counterbalanced sash assembly for years of trouble free use
- Tempered safety glass with Easygrip® hand rail
- 2 side access panels built into inner liner for future addition of utilities
- Stainless steel airfoil designed to maximize air sweep of work surface
- All fume hoods comply to exhaust requirements and face velocity test as per ASHRAE 110-95; when ordered with control systems, units also comply to BS 7258 and EN 14175

Laboratory Fume Handling

Laboratory fume hoods or fume cupboards represent the primary line of defense for personnel against exposure to harmful, toxic and dangerous fumes or chemicals as they are produced.

“Fume hoods are essentially aerodynamic scavenging devices that remove dangerous fumes from a laboratory and expel it into the environment where it is sufficiently diluted to no longer pose a health risk.”

Advancelab Laboratory fume hoods have been manufactured to provide the highest levels of safety for laboratory personnel.

Fume hoods when sized with an appropriate chemical resistant centrifugal exhaust fan will protect laboratory staff from exposure to harmful fumes.

Please contact our distributors or offices to help or design an efficient exhaust system.

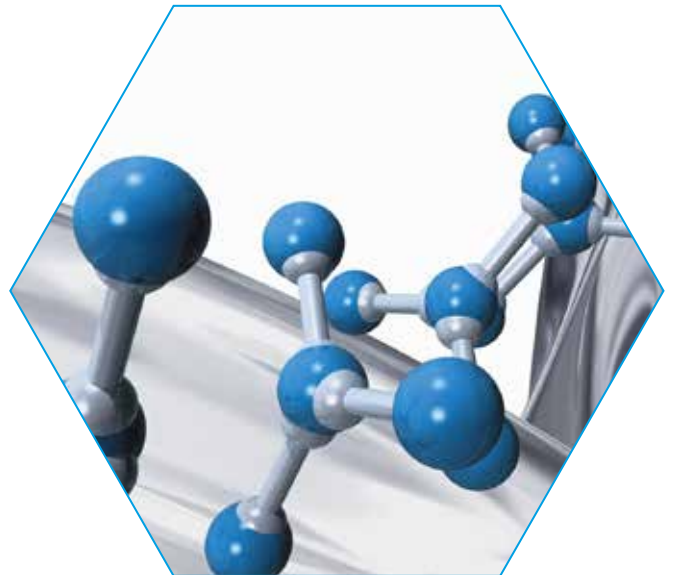

Stainless Steel Fume Hood AD Series

- Stainless Steel Construction
- Aerodynamic Front Fascia
- Stainless Steel 304 Worktop

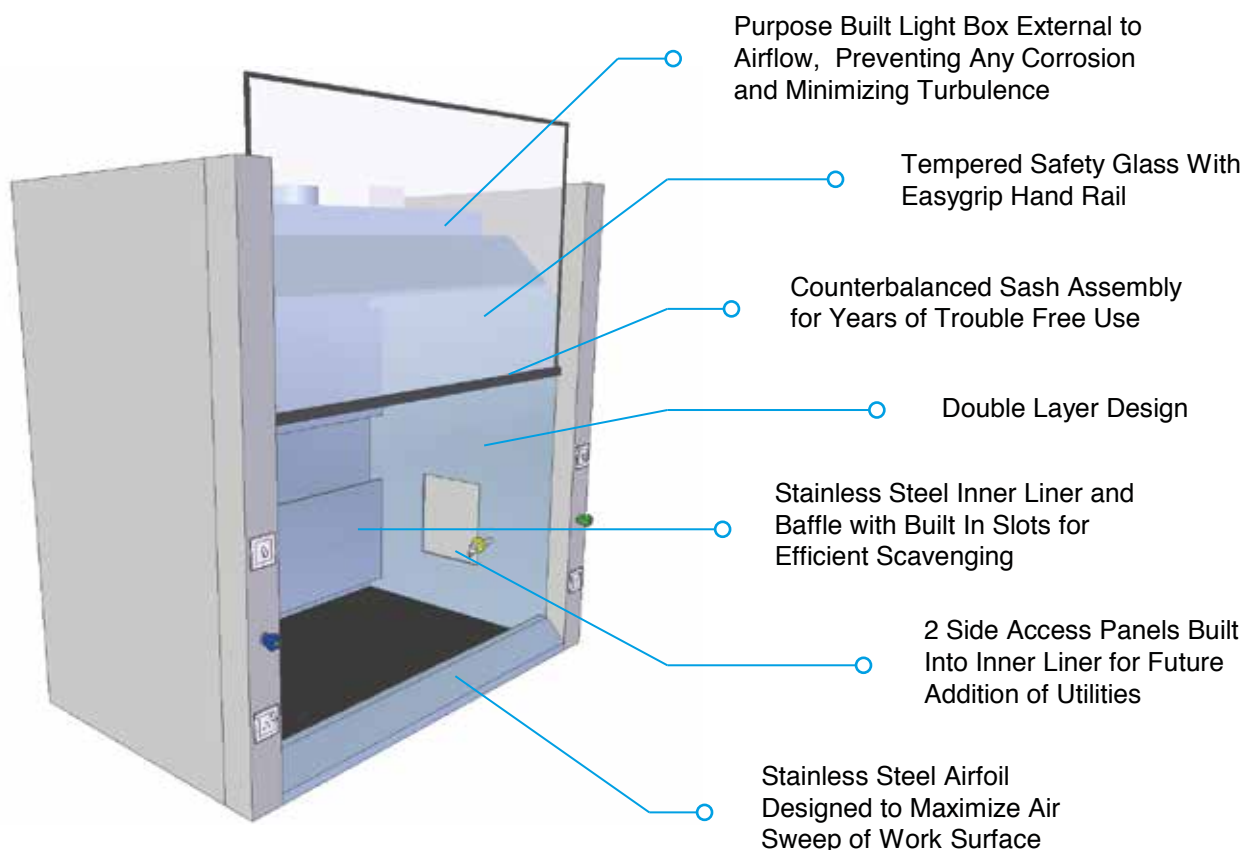
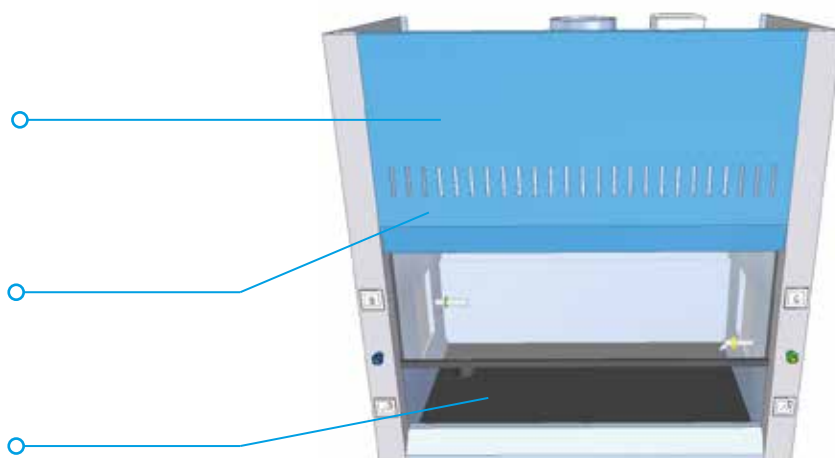

Models

MODEL	AD04FH-SS	AD05FH-SS	AD06FH-SS	AD08FH-SS
Dimensions, mm (LxWxH) Including base cabinet	1220mm x 920mm x 2420mm	1520mm x 920mm x 2420mm	1820mm x 920mm x 2420mm	2420mm x 920mm x 2420mm
Body	Stainless Steel			
Worktop	Stainless Steel			
Inner Liner & Baffle	Stainless Steel			
Airfoil	Stainless Steel			
Standards Complied	ASHRAE 110-95 BS 7258 (with Optional Controller) EN 14175 (with Optional Controller)			
Services	<ul style="list-style-type: none"> • 1 Pre Plumbed Cold Water Remote • 1 Pre Plumbed Gas Remote 		<ul style="list-style-type: none"> • 2 x Pre wired 13 Amp Switch socket outlets (BS) • 1 Stainless Steel Custom Sink 	
Controls	Fan ON/OFF switch Light ON/OFF switch			
Base	Stainless Steel			
Duct Collar	200 mm	250 mm	300 mm	300 mm x 2
Design Velocity	0.5 m/s at 500mm sash height			
Extract Volume at 500 mm Height Sash Opening	1188 CMH	1512 CMH	1836 CMH	2481 CMH

Ergonomic Sash Handle

Gently directs air into
the hood without
sacrificing visibility.

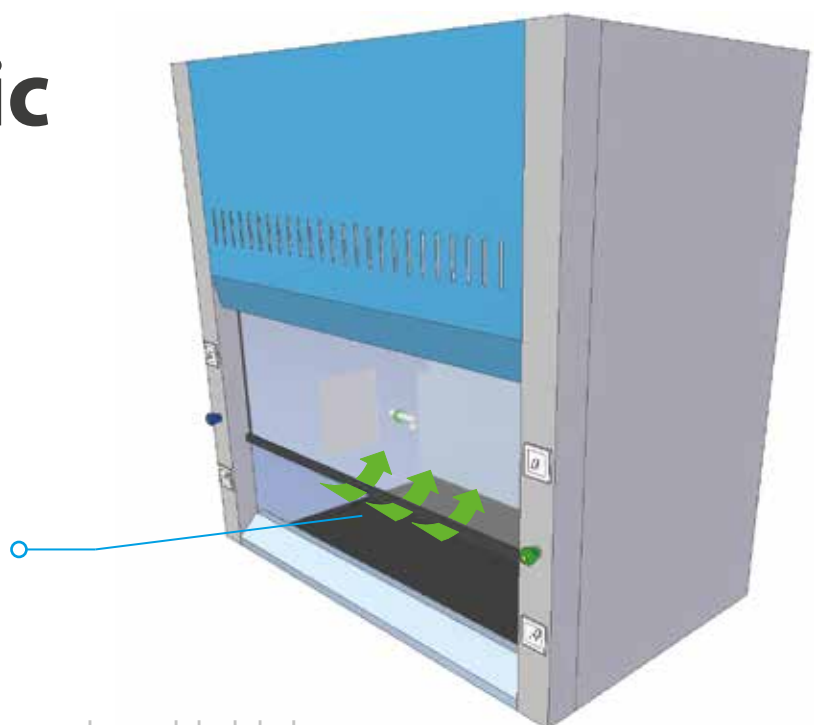

Parts

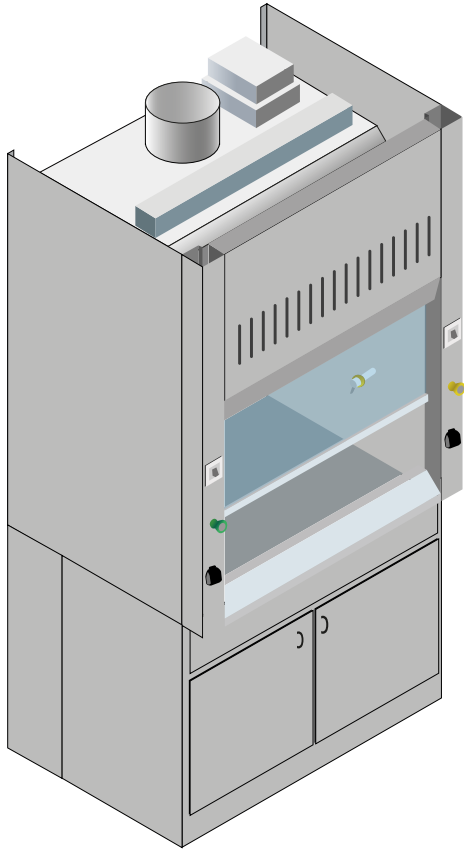

1. PVC Exhaust Collar
2. Electrical Junction Box
3. External Light Box
4. Side Access Panel
5. Stainless Steel 304 Airfoil
6. Removable Front Panel
7. Tempered Glass Sash
8. SS Custom Sink
9. SS Worktop
10. Fan ON/OFF Switch
11. Light ON/OFF Switch
12. Gas Fixture Remote
13. Water Fixture Remote
14. Gas Faucet
15. Water Faucet
16. Electrical Outlets

Top View

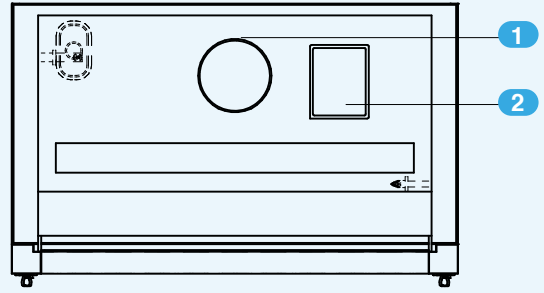

Side View

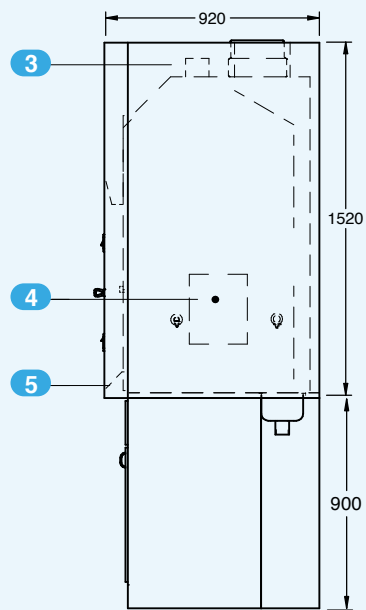

Front View

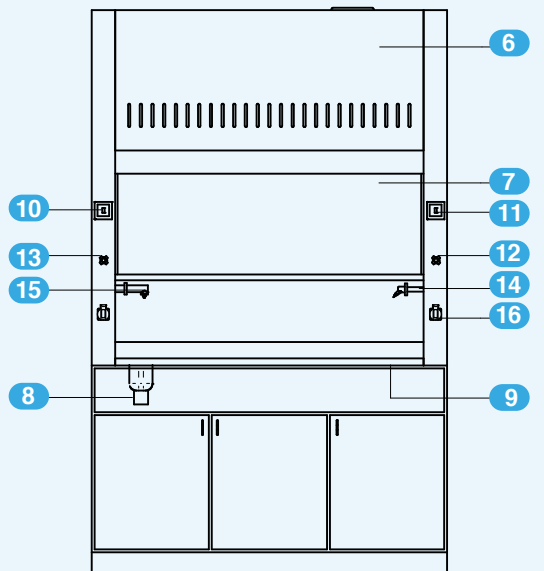

Options and Accessories

Superstructure

- SS 304, 4B
- SS 304, 2B
- SS 316

Inner Liner Construction

- SS 304, 4B
- SS 304, 2B
- SS 316

Work Top

- SS 304, 4B
- SS 304, 2B
- SS 316

Distillation Grid

- Aluminium
- SS 304
- SS 316

Sink

- Custom Sink
 - SS 304
 - SS 316
 - Size: _____ mm (L x W x H)
please specify

- Location
 - x = _____ mm
 - y = _____ mm

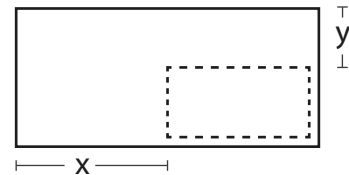

Microprocessor Airflow Alarm

- Digital Display with Alarm
- Digital Display with Alarm & VAV/VSD Output



Services

- Compressed Air (CA)
- Distilled Water (DI)
- Nitrogen (N2)
- Oxygen (O2)
- Vacuum (Vac)

Ex Proof Configurations

- Ex proof lights
- Ex proof on/off switch
- Ex proof Electrical Sockets
- Ex proof electrical junction box

Please advice factory of details required

Electrical Outlet

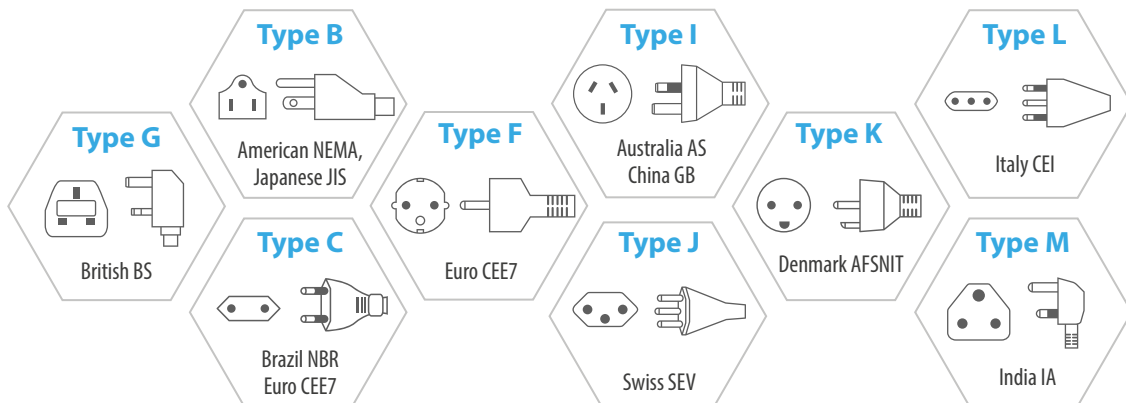

Warranty

Products Manufactured by Advancelab: Advancelab(S) Pte.Ltd., warrants products that it manufactures to be free from defects for a period of 12 months for parts, commencing from the date of shipment. Advancelab's sole responsibility is to repair or replace, at its option, any part of the product that proves defective or malfunctioning during this time limit. This warranty is void if the equipment is abused or modified by the customer, is operated outside Advancelab's operating instructions or specifications, or is used in any application other than that for which it is specified. This warranty does not include routine maintenance or service procedures, breakage, shipping damage, nor damage from misuse, intentional or unintentional abuse, neglect, natural disasters, or acts of God.

Freight Shortage or Damage: Upon receipt of any equipment from Advancelab, customer shall immediately unpack and inspect for damage or shortage. The customer shall not accept a damaged package or a short shipment until the carrier makes a "damage or shortage" notation on both the carrier's and customer's copy of the freight bill or delivery receipt. Service title passes when the shipment is loaded, so customer is responsible for filing and collecting a freight claim. Any replacement products must be ordered and paid for separately.

Generally, customers can improve the chance of collecting on a freight claim by following these procedures:

1. Formally requesting that the carrier inspect the shipment immediately upon suspecting damage or shortage to verify condition.
2. Notifying the carrier upon discovery of concealed damage and requesting an inspection within 15 days of receipt, both in person or phone and following up via mail.
3. Keeping the shipment as intact as possible, including retaining original packaging materials and keeping the product as close to the original receiving location as possible.
4. Holding salvage for disposition by the carrier.

All Claims: Advancelab (S) Pte.Ltd., expressly disclaims all other warranties, expressed or implied or implied by statute, including the warranties of merchantability or fitness for intended use. Advancelab is not responsible for consequential or incidental damages arising out of the purchase or use of the products supplied by Advancelab. Advancelab is not liable for damage to facilities, other equipment, products, property or personnel of others, or of their agents, suppliers, or affiliated parties, which is caused or alleged to have been caused by products supplied by Advancelab. In any event or series of events, Advancelab's total liability for any and all damages whatsoever is limited to the lesser of the actual damages or the original invoice cost of the items alleged to have caused the damage. The customer's sole and exclusive remedy for any cause of action whatsoever is repair or replacement of the non-conforming products or refund of the actual purchase price, at the sole option of Advancelab. All claims must be made in writing within 90 days of the date the product was shipped. Any claims not made within this time limit shall be deemed waived by the customer. Advancelab is not responsible for any additional costs of repair caused by poor packaging or in-shipment damage during return.

Warranty Returns: All warranty returns must be authorized in advance by Advancelab and approved by writing. Unless approved in advance for good reason, all returns must be in original condition, including all manuals, and must be packaged in original packaging materials. All returned goods are to be shipped to Advancelab, freight prepaid at customer's expense.



STAINLESS STEEL

AdvanceLab has built a rock steady reputation for solutions where most fail. Since our establishment in 2003, we have positioned ourselves as the premier facility solution provider for the scientific industry; designing, building and delivering quickly and without fuss. We have also taken our brand of expertise globally; now with exports of laboratory casework, fume hoods, laminar flow cabinets and clean booths heading to 30 countries, covering all continents.



FUMEE HOOD

Indonesia

PT. Advancelab Saintifik

253 Kaki Bukit Ave 1
Singapore 416061
Tel: +65 6448 8255
Fax: +65 6448 9833
Email: info@advancelab.com.sg

Malaysia

Advancelab Sdn Bhd

No. 3388, Jalan Pekeliling Tanjung
27/2, Kawasan Perindustrian Indahpura,
81000 Kulaijaya, Johor, Malaysia.
Tel: +607 660 8877
Fax: +607 660 8866
Email: info-my@advancelab-global.com

Myanmar

Advancelab Scientific & Engineering Co., Ltd

No.(81/1)-1A, Myin Thar 7th Street,
(14/1)Ward, South Okkalapa Township,
Yangon, Myanmar
Tel: +95 (9) 779753802
Email: info-mm@advancelab-global.com

Singapore

Advancelab (S) Pte Ltd

253 Kaki Bukit Ave 1
Singapore 416061
Tel: +65 6448 8255
Fax: +65 6448 9833
Email: info@advancelab.com.sg
Website: www.advancelabglobal.com

Thailand

Prima Scientific Co., Ltd.

147 / 170 - 171 Baromrajchonnanee
Road, Arunamarin Bangkoknoi, Bangkok
10700, Thailand.
Tel: +66 2 884 9480
Fax: +66 2 884 6441
Email: primasci@primasci.com

Website:
www.advancelabglobal.com

Indonesia • Malaysia • Myanmar • Philippines • Singapore • Thailand

